

# **BIANCO** **iCON** SERIES **DRIVES**

Bia iSub22 PN 802677  
Bia iSub37 PN 803809



# 1. Contents

1. Contents.....	2
2. Introduction.....	3
3. Key Features, Protections and Conformities.....	3
4. Technical Specifications .....	4
5. ISO 7010 Symbols used in this manual.....	4
6. Warnings and Cautions .....	5
7. Electrical Connections .....	6
8. Wiring - Summary.....	6
9. Display .....	7
10. Display Functions Explained.....	8
11. Controller Programming.....	9
12. Exiting Programming Mode.....	9
13. Installation.....	10
14. Pump and Motor Installation.....	11
15. Basic tuning .....	12
16. Intermediate Tuning - System Sleep Mode.....	12
17. Advanced Tuning.....	13
Systems requiring a 16 or 25 bar transducer .....	13
Low water level control – Float or water level probes.....	13
Terminal Run/Stop and Auto/Manual Switching.....	13
Multi Pump control.....	13
Day Part Run Time .....	14
18. Ensuring bore motor cooling.....	14
19. Factory Default Parameter Values.....	15
20. Faults and Trouble Shooting Guide.....	17
21. Maintenance.....	18
22. Warranties – Terms and Conditions .....	19

## 2. Introduction

Congratulations on the purchase of your iCon iSub Variable Frequency Borehole pump.

The controller at the heart of the system accepts 240V single phase input power.

It converts this to 240V 3 phase output power to drive a Tesla 240V 3 phase borehole motor with a range of multi-stage pump wet-ends to cover a wide range of pressure and flow requirements.

The iCON iSub VFD conserves energy by only operating the pump at the speed required to maintain set-point pressure. It is great for systems with variable demand.

The Controller is prewired and mounted in a weather resistant enclosure with independent fan cooling and an inspection window.

The iSub controller arrives with the majority of settings pre-programmed and requires only minimal extra tuning.

The kitset includes a 1" stainless manifold to make adding a pressure vessel easy and with ports for the pressure transducer and pressure gauge to get you up and running swiftly.

## 3. Key Features, Protections and Conformities

### Features:

- Constant water pressure.
- Optimised pump performance.
- Soft start, low motor start current.
- Low water level control option.

### In built Pump Protections:

- Dry run protection.
- High and low voltage protection.
- Input and output short circuit protection.
- High and low water pressure protection.
- Input and output phase failure protection.
- Over temperature protection.
- Sensor fault protection.

### Conformity:

- Verification of EMC compliance certificate no. AC/0410709 to EN 61326-1:2006, EN 61000-3-2:2005, EN 61000/3/3:1995+A1:2001+A2:2005.
- Verification of LVD compliance certificate no. AC/0420709 to EN 61010-1:2001.

### iSub Bore Pump Kit Contents

- Variable Frequency pump controller in steel cabinet with cooling fan and circuit breaker.
- Stainless steel manifold.
- Pressure transducer
- Pressure gauge
- Installation manual.

### Supplied separately as part of iSub Borehole Pump Kit:





- DAB Borehole Pump, with up to 2.2 kW 3ph 240V motor.
- 18 litre pressure tank.

## 4. Technical Specifications







Function	Variable speed, Constant Pressure Water supply
Modes	Configured for Single pump control <i>Multi pump systems available on request</i>
Power Supply Voltage	240V +/- 15%% 1 ph 50/60Hz AC
Output voltage	240V 3 ph AC
Output frequency range	0 – 50/60Hz
Working temp range	0 - 40°C
Working humidity range	20 – 90%
IP Rating	Controller IP22. Enclosure IP56
Enclosure Dimensions	520 (H) x 320 (W) x 240 (D)

Model No.	B603B Model ID	Rated Input Current (A)	Rated Output Current (A)	Nominal Motor Current (kW)
Bia iSub22	B603B-4003	5.8	5.0	1.5
Bia iSub37	B603B-4005	10.0	9.0	2.2

## 5. ISO 7010 Symbols used in this manual

	Warning - Electrical safety
	Warning – Potential consequences of use outside of intended application(s). Includes environmental condition warnings.
	Mandatory warning
	Warning to disconnect power
	Read carefully

## 6. Warnings and Cautions

	<p>Read the manual carefully before starting and retain for future reference.</p>
	<p>Prior to starting installation or maintenance the controller must be disconnected from the power supply. Allow 5 minutes for the internal electronics to discharge before opening the cover</p>
	<p>Any changes or modification to the wiring must be carried out by competent, skilled and suitably qualified personnel only.</p>
	<p>A qualified electrician should correctly size and install circuit breakers to protect the power supply. The fitment of additional surge protection is recommended.</p>
	<p>Never open the cover while controller is connected to electrical supply. Disconnect and allow 5 minutes for the internal electronics to discharge before opening the cover</p>
	<p>This appliance is not intended for use by persons (including children) with reduced physical, sensory or mental capabilities, or lack of experience and knowledge, unless they have been given supervision or instruction concerning use of the appliance by a person responsible for their safety. Children should be supervised to ensure that they do not play with the appliance.</p>
	<p>Avoid installing the iCon iSub where it could experience the following conditions:</p> <ol style="list-style-type: none"> <li>i. Where there is significant vibration and/or mechanical shock.</li> <li>ii. Where it could be exposed to corrosive liquids or gasses, or to flammable materials, solvents etc.</li> <li>iii. Extreme heat and cold. Operating range 0°C - 40°C.</li> <li>iv. Protect the controller from rain, moisture, humidity or dust</li> </ol>

## 7. Electrical Connections

It is good practice to locate the controller as close to your water source as possible and near to a suitable power supply.

Always use an electrical outlet that is protected by Residual Current Device (RCD) Safety Switch with a trip current of 30mA or less. A Safety switch is required by Australian/New Zealand Standard AU/NZS 60335.1-2011.

This must be connected by a suitably qualified technician.



## 8. Wiring - Summary

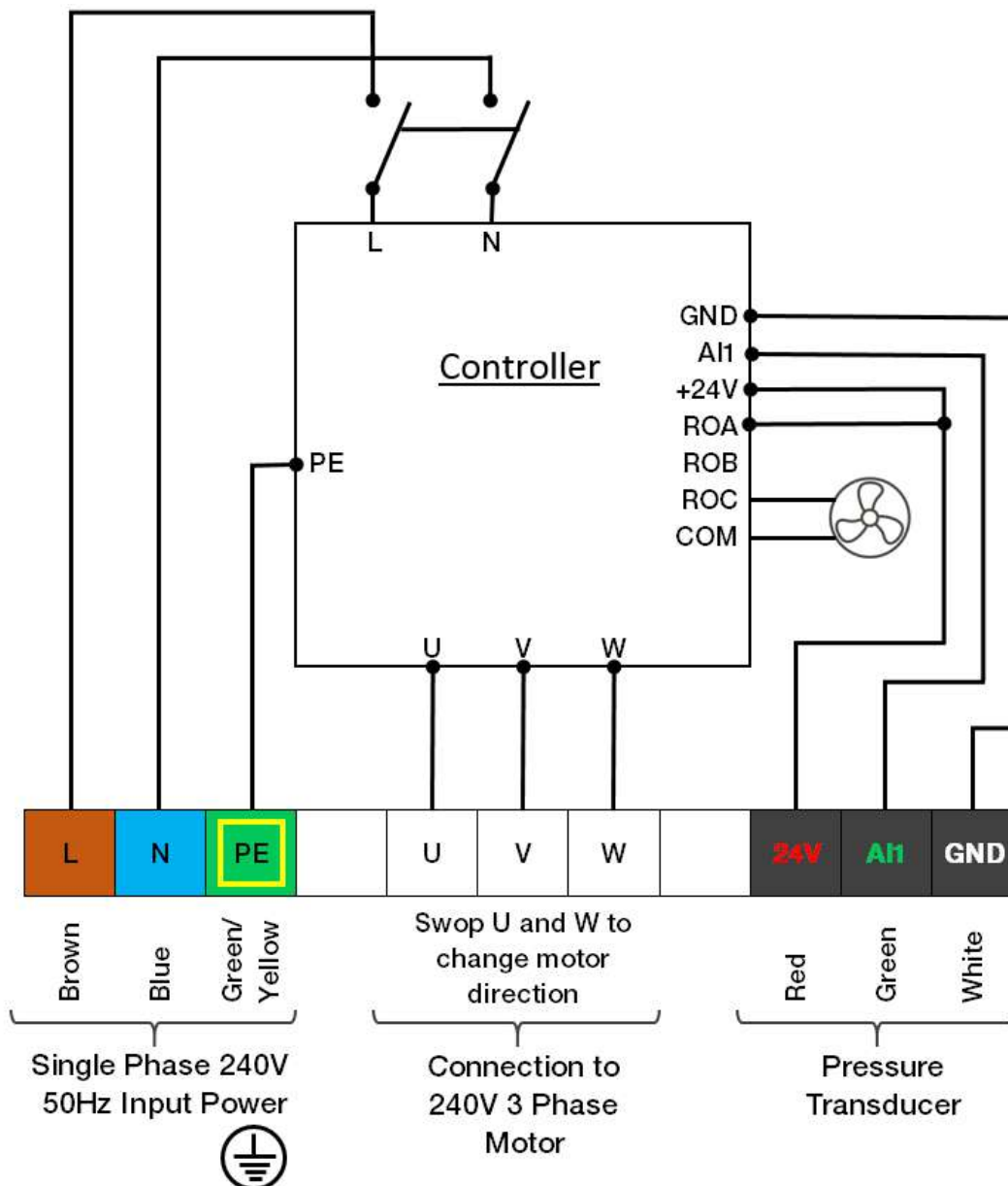

# 9. Display

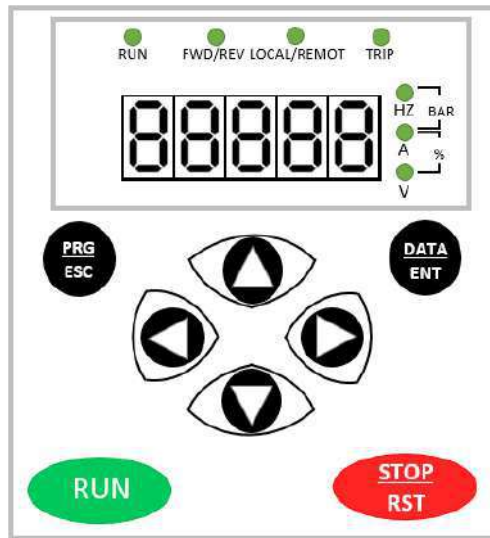

Viewing Current Operating Values (*Top level*)

Navigate using



## Standby Mode

## Run Mode

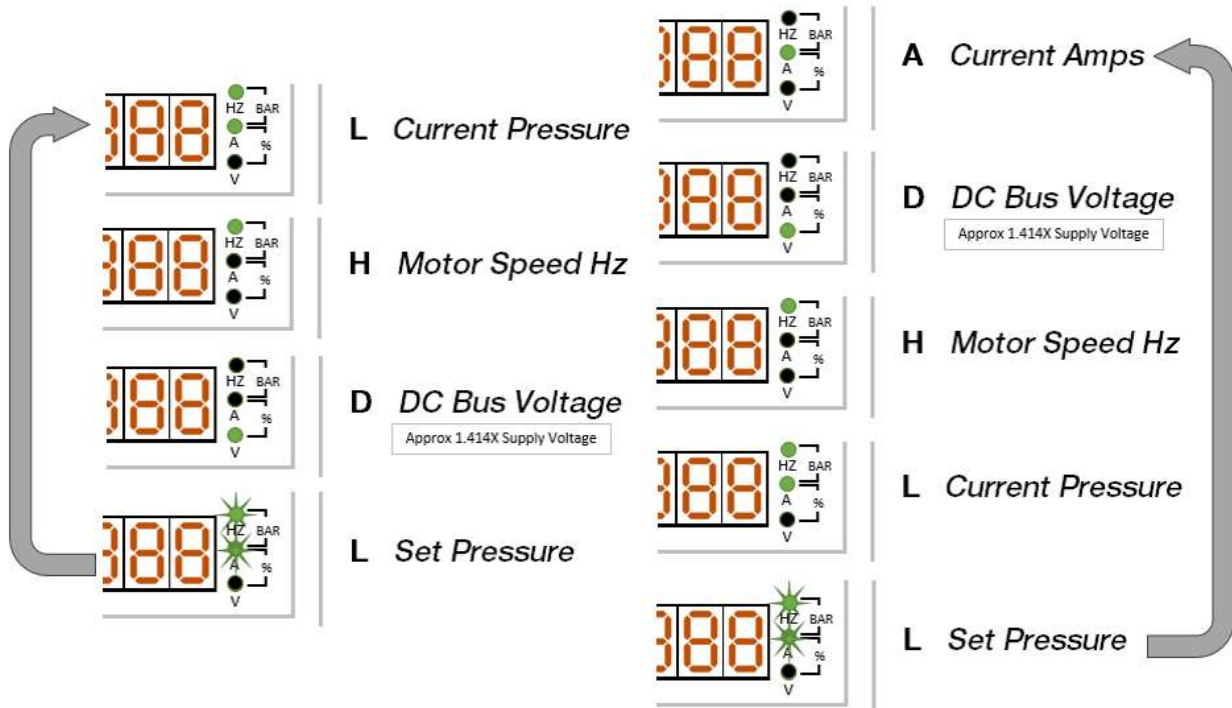





The operating set point pressure can be altered at any time using the UP and DOWN buttons. Any changes in this manner are not saved to parameter **b00.01** unless **DATA/ENTER** is pressed to lock in the change.



*Altering the operating pressure may impact on the ability of the pump to enter sleep mode.*

## 10. Display Functions Explained

Element Function	Explanation
<b>RUN LED</b>	Light on: Operational status Light off: Stop or standby status
<b>FWD/REV LED</b>	Light on: Reverse Operation Light off: Forward Operation
<b>LOCAL/REMOT LED</b>	Light on: Auxiliary Controller Light off: Master controller
<b>TRIP LED</b>	Light on: Active Fault Status Light off: Normal operation
<b>Hz LED</b>	Flickering or light on when displaying frequency
<b>A LED</b>	Light on when displaying current
<b>V LED</b>	Light on when displaying (internal bus) voltage
<b>BAR - LED PAIR</b>	LED's steady = Current pressure value displayed LED's flashing = Programmed set pressure value displayed
<b>% - LED PAIR</b>	Both LED's illuminated when displaying percentage
<b>DIGITAL DISPLAY</b>	5 digit LED screen displaying operating values, parameter settings and alarm codes
	Enter Programming mode from Top Level ALSO Undo previous button press / level up
	Progressively enter menu AND confirm parameters
<b>UP</b>	Under normal (non-programming) operation the UP and DOWN buttons alter the pump operating pressure parameter <u>without</u> entering programming mode.
<b>DOWN</b>	In programming mode the UP and DOWN buttons are used to increase or decrease the relevant value on display
<b>LEFT SHIFT</b>	In normal (non-programming) operation the left and right shift buttons cycle through the display options
<b>RIGHT SHIFT</b>	In programming mode the left and right shift buttons move the cursor to the digit to be altered
	Instructs the controller to enter operational status. <b>Green LED RUN</b> (top left) will illuminate
	Instructs the controller to exit operational status. In the event of an fault/error code, pressing STOP/RST will clear the fault and allow the controller to resume normal operation



## 11. Controller Programming

The iSub is intended to be simple to install and tune. Due the differences between installations a small amount of tuning cannot be avoided.

If even after following the programming instructions  
you require assistance contact White International 0800 509 506



Until users are familiar with navigating the programming menu it can be difficult to register whereabouts in the program you are. At any time, pressing the PRG/ESC button repeatedly (up to 3 times) will return you to the Top Level

Once in the programming menu the format of the display provides a clear indication.

At Level 2 the desired parameter group can be selected. The display will indicate **br-00 – br-07**

Once entering a parameter group into Level 3 the display is subtly different i.e. **b01.09** etc.

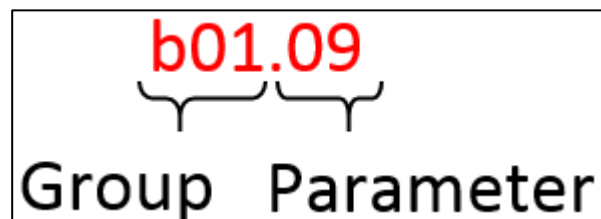

### Entering programming mode

- Set the controller to standby mode by pressing **STOP/RST**.
- The **Green LED RUN** (top LH of display) will be dark.
- Press **PRG/ESC** then **DATA/ENT**. The display will read **b00.00**
- Press **DATA/ENT**. The display will read **00000** (the RH zero will be flashing). *If the RH zero isn't flashing, press **STOP/RST***
- Use **▲ ▼** buttons to increase/decrease values and the **< >** buttons to scroll sideways
- Enter (default password) **65535**
- Press **DATA/ENT** and Groups br-01 to br-07 are unlocked. The display will now read **b00.01**
- Press **PRG/ESC** to return to Level 2.

## 12. Exiting Programming Mode

Navigate to **b00.00** Press **DATA/ENT**. The display will read **00000** (the RH zero will be flashing).

Press **DATA/ENT** to accept this value OR enter an otherwise invalid password i.e. **00001**

The display will read now **b00.00** but it is no longer possible to navigate within Level 3, nor Level 2 after pressing **PRG/ESC**.

Press **PRG/ESC** to return to the Top Level.



*Programming should be carried out with care. Parameters randomly modified or altered in error can induce abnormal operation and have the potential to harm the controller as well as the water supply system, or even to cause personal injury or accidents.*

## 13. Installation

1. Mount the controller cabinet securely close to the manifold and pressure sensor.
2. Fit an earth wire (>3.5mm<sup>2</sup>) to ground the controller and cabinet
3. Connect the pump motor wiring to the controller
4. Connect transducer to controller

a. Red = 24V, Green = AI1, White = Ground



b. The transducer supplied is rated to a maximum of 10 bar pressure. If a sensor with a higher rating is used. See Section 17, Pg 13

c. Avoid extending the pressure sensor wiring where possible

5. Connect Power to controller
6. Check and alter controller parameters as per the suggested settings Section 15, Pg 12
7. Check direction of pump motor rotation (looking at the shaft, correct direction is anti-clockwise)  
If the direction is incorrect, set b00.02 to setting value 1 OR swop U and W wires
8. Set the desired operating pressure using the  $\wedge$  V buttons. Press DATA/ENT to store.
9. Set the pressure tank pre-charge air pressure at 66% of the operating pressure
10. Install the pump and motor
11. Prime the system to remove any air (throttle using discharge valve)
12. Ensure pump can maintain its set point pressure and can enter sleep mode when the discharge valve is closed. If the controller will not enter sleep mode the minimum Hz may need adjusted) See Section 16, Pg 12

## 14. Pump and Motor Installation



User manuals are supplied with the pump 'wet-end' and the motor.  
Read the manuals carefully before starting and retain for future reference.

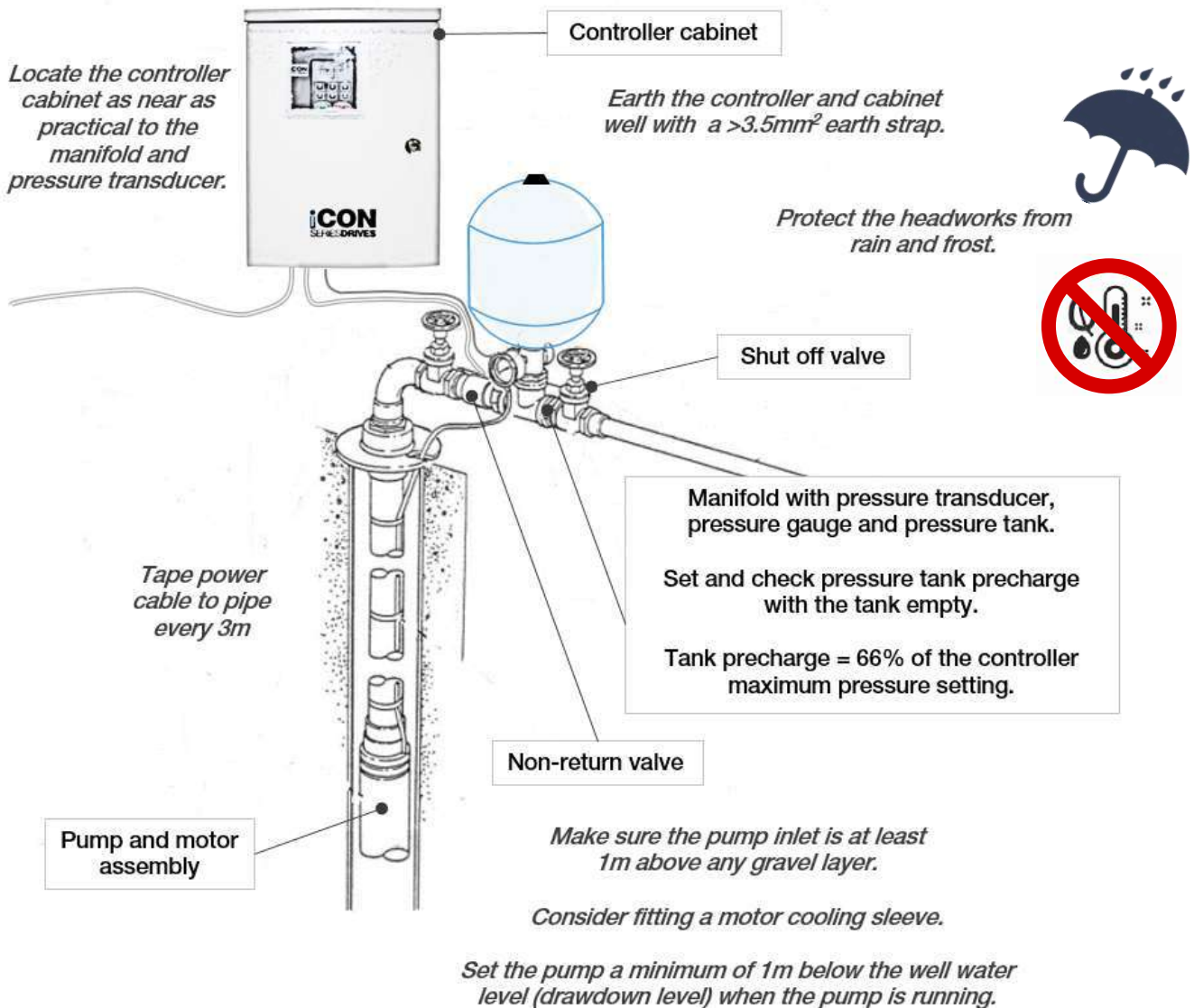

Additional low water level protection using a float or probes can be added to the controller. This is particularly relevant with low yielding bores.

Contact White International for details and assistance.



## 15. Basic tuning

Section 11, Pg 9 explains how to enter and exit programming mode.

After reviewing this information the following parameters will require tuning

br00.01	Operational pressure	As per your requirement
br00.02	Motor Direction	As default (0) unless required (CONFIRM DIRECTION ON COMMISSIONING See Pg 10)
br04.03	Sleep Wake up Differential	Default is 0.5 bar pressure drop
br05.03	Acceleration time	Suggest setting at 1.0 Second
br05.04	Deceleration time	Suggest setting at 1.0 Second
br05.07	Lower Frequency Limit	Not less than 35Hz
b01.00	High water pressure alarm	Default = 8 bar. Set above maximum system pressure

## 16. Intermediate Tuning - System Sleep Mode

As the water demand falls the controller reduces the pump operating speed.

With the Sleeping Function Group operational (**b04.00** - select 1 to validate) once minimum frequency is reached (**b05.07**), after the sleeping wait time (**b04.01**) is exceeded the controller will begin its sleep down cycle.

The output frequency will 'dip' 3 times according to the setting of **b04.02** - which is a percentage of the pump motor rated frequency.

If pressure is maintained throughout the shutdown cycle the controller reasonably assumes flow has ceased and will enter sleep mode.

The pump will recommence operation once the wake up pressure bias (**b04.03**) is exceeded.

If the pump is unable to maintain its operating set point pressure **b00.01** throughout this cycle it will not shut down and will continue to run at the set minimum frequency.

This situation can occur when the pump curve is very flat.

In this situation you have 3 options:

Reduce the Sleeping test Frequency Proportion **b04.02**. Default is 4%. Try 2%

Increase the minimum frequency **b05.07**

Decrease the operational set point pressure **b00.01**

An unwillingness to sleep can also be the result of leaks in the system.

## 17. Advanced Tuning

The iSub controller is capable of a number of advanced functions.  
For additional information contact White International 0800 509 506



### Systems requiring a 16 or 25 bar transducer

iSub models S4A25, S4A50, S4B32, S4B48, S4C25, S4C39 and S4E17 have the potential to develop pressures greater than 10 bar (102m head) at the pump outlet. The pressure at the pressure sensor will be less, depending on the well depth.

If the pressure at the manifold (pressure sensor) will be greater than 10 bar, the pressure sensor, pressure tank and pressure gauge will need to be replaced with suitably rated items.



### Low water level control – Float or water level probes

A level control switch can be connected between S3 and COM if required.

- Use Parameter **b05.00** to select NC or NO switch signal. Default = 2 Normally open  
1 = NC, 2 = NO, 0 = Invalid
- Parameter **b05.01** enables a delay time to be selected to prevent excessive stop/start in the event of rapid switching signal to S3
- Contact White International for additional information about connecting and using probes to sense water level.

### Terminal Run/Stop and Auto/Manual Switching

Connecting a switch between S1 and COM allows for remote ON/OFF

- A shielded, twisted pair is recommended to wire the switch
- Set parameter **b05.02** to 3 to validate ON/OFF Switching  
Switch on = the pump will run. Switch off = the pump will stop
- When a switch is installed between S1 and COM the RUN and STOP/RST buttons on the controller are no longer active

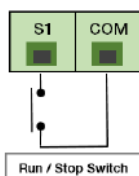

#### Terminal Run/Stop Control Wiring

S1-COM (On): Run

S1-COM (Off): Stop

Instructs the control to enter or exit automatic operation

### Multi Pump control

Up to 6 pumps can be connected together for Master/Slave or Synchronous operation.  
Contact White International for additional information.

## Day Part Run Time

Day part run time allows the user to set varying conditions around operating pressure (and minimum inlet pressure) for pre-set periods of time.

Up to 3 time periods can be programmed.

The Day Part run time is useful where a different set point is desirable for a regular but limited part of the day.

It can be utilised for irrigation applications to coincide with zone timings where, due to friction losses, zone size or elevation, a different pressure is required to achieve equivalent performance from the spray nozzle.

Another application for this feature is where there are storage tanks at a higher elevation. The system timings can be set to ensure that tank is filled at a certain time that doesn't interfere with the 'normal' system operating pressure.

Contact White International 0800 509 506 for more information



## 18. Ensuring bore motor cooling

A flow inducer sleeve is recommended to ensure greater than 76mm/sec water velocity across the motor to ensure adequate cooling.

A flow rate greater than 48lpm when installed in a 6" (152mm) casing will achieve this requirement.

DAB Wet End minimum and maximum flows			Recommended flow inducer I.D. to cool motor at <u>minimum</u> flow rate
	Minimum	Maximum	
S4A	5	25	102mm ID
S4B	10	40	108mm ID
S4C	20	70	120 mm ID
S4D	30	100	130 mm ID
S4E	60	190	160mm <i>Not required for 6" casing</i>
S4F	150	450	225mm <i>Not required for 6" casing</i>

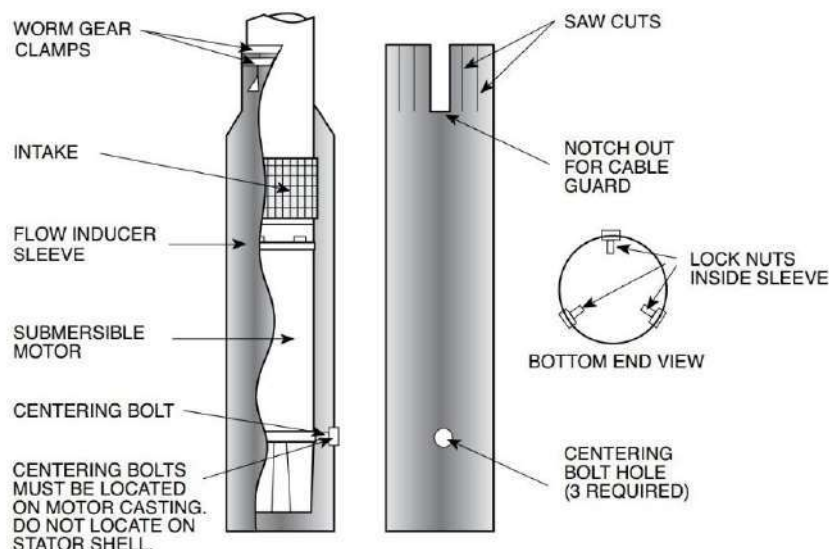

## 19. Factory Default Parameter Values

Address	Factory Default	Address	Factory Default	Address	Factory Default	Address	Factory Default
b00.00	65535	b01.00	8.0	b02.00	0	b03.00	02
b00.01	3.0 bar	b01.01	0.5	b02.01	0	b03.01	3
b00.02	0	b01.02	20	b02.02	0	b03.02	0
b00.03	0	b01.03	5.00	b02.03	2.50	b03.03	15
b00.04	0	b01.04	1.0	b02.04	1.00	b03.04	0.0
b00.05	20.0	b01.05	10.0	b02.05	0.00	b03.05	0
b00.06	15.00	b01.06	1.00	b02.06	0.10	b03.06	0
		b01.07	0	b02.07	0.00	b03.07	0.10
		b01.08	5.00	b02.08	1.0	b03.08	0
		b01.09	100	b02.09	0.0	b03.09	2
		b01.10	0.10	b02.10	1.0		
		b01.11	1.00				
		b01.12	0.0				
		b01.13	5.00				
		b01.14	100.0				
		b01.15	0.10				
		b01.16	1				
		b01.17	1				

Address	Factory Default	Address	Factory Default	Address	Factory Default	Address	Factory Default
b04.00	1	b05.00	2	b06.00	0x01F	b07.00	0
b04.01	5.0 (sec)	b05.01	1 (min)	b06.01	0x00F	b07.01	0
b04.02	4 %	b05.02	0	b06.02	3	b07.02	3.0
b04.03	0.5	b05.03	1.0	b06.03	5	b07.03	0
b04.04	0.0	b05.04	1.0	b06.04	3 <sup>rd</sup> last Fault	b07.04	2.0
		b05.05	50.00	b06.05	2 <sup>nd</sup> last Fault	b07.05	0
		b05.06	50.00	b06.06	Latest Fault	b07.06	3.0
		b05.07	35 Hz	b06.07	0	b07.07	0
		b05.08	08.0	b06.08	Read Only	b07.08	2.0
		b05.09	10.0	b06.09	65535	b07.09	0
		b05.10	8.00			b07.10	3.0
						b07.11	0
						b07.12	2.0
						b07.13	0.0
						b07.14	0
						b07.15	00000

b06.04	3 <sup>rd</sup> last Fault	E000: Fault Free
b06.05	2 <sup>nd</sup> last Fault	E001: INU U Phase Protection E002: INU V Phase Protection E003: INU W Phase Protection E004: Acceleration OC E005: Deceleration OC E006: Constant velocity OC E007: Acceleration OV E008: Deceleration OV E009: Constant velocity OV E010: Busbar Under-voltage E011: Motor Overload E012: Controller Overload E013: Input phase failure E014: Output phase failure E015: Rectifier Module Overheat E016: Inversion Module Overheat E017: External fault E018: Communication Fault E019: Current sense fault E020: Reserved E021: EEPROM Operation fault E022: Transducer Fault E023: Reserved E023: Reserved
b06.06	Latest Fault  To erase faults: <b>b07:14</b> Enter 2	

If the controller is behaving in an unusual manner it is highly possible that a parameter has been altered in error. In this event, navigate through each Group and every Parameter, resetting to factory default values.

Afterwards recommence programming from the very beginning.

Keeping a record of programmed parameter values is highly recommended and will assist fault finding.



Programming should only be carried out by suitably trained personnel. Parameters randomly modified or altered in error can induce abnormal operation and have the potential to harm the controller as well as the water supply system, or even to cause personal injury or accidents.

In the event of difficulties contact White International 0800 508 509





## 20. Faults and Trouble Shooting Guide

HP	High Water Pressure	Parameter <b>b01.00</b> is too small or Back pressure affecting system	Check the pressure transmitter installation Ensure parameter <b>b01.00</b> is not set too low Check the system for non-pump or controller issues
LL	Low water Level	Occurs if a sensor is connected to Terminal S3	Displays if the sensor connected to Terminal S1 is registering a low reading and prevents the controller running the pump.
E022	Sensor Fault	PID feedback from Pressure Transducer disappears	Pressure transmitter disconnected or Pressure transmitter short circuit. Check the pressure transmitter Check the cable between the controller and the pressure transmitter
EXXX Faults	If the controller is displaying an 'E' fault code, contact White International The last 3 fault codes history can be accessed at <b>b06.06 -b06.04</b>		

Symptom	Possible Cause	Suggested solution
Controller won't enter sleep mode	Wrong Parameter Leaks on output side of the system NRV leakage Pressure tank damaged High EMI environment	Check <b>b04.00</b> is valid (setting 1) Alter (increase) <b>b04.04</b> Sleeping bias or decrease <b>b04.02</b> value Check Pressure tank. Re-pressure or replace as required Ensure transducer wiring is shielded. Shield layer connects to PE
Display Pressure error	Sensor error Wrong Parameters Transducer wires too long	Fault check sensor and consider replacement Calibrate <b>b01.05, b01.08</b> Shorten transducer wiring
Continuous full frequency running	Lost pressure feedback signal Wrong Parameters Pump under sized	Check transducer and wiring Check <b>b05.02</b> (auto/manual) setting is correct Default is 0 <b>S2 COM</b> should be open Consult pump performance curve and verify the pump selection is correct

## 21. Maintenance

- Maintenance must be performed according to designated maintenance methods
- Maintenance must be performed by authorized personnel only
- After turning off the main circuit power supply, please wait for 5 minutes before starting work or opening the controller cover
- DO NOT directly touch components or devices of PCB board without taking suitable precautions. The controller can be damaged by static electricity
- After maintenance, all screws must be tightened

1. Controller	Ensure there is no abnormal vibration, heat noise or smell coming from the controller
2. Fans	Ensure fans are working and in good condition and that air speed and airflow are normal
3. Motor	Remain alert to abnormal vibration, noise, heat or for any open phase problems

### Periodic Maintenance

Operation can suffer if the controller suffers over-heating. Ambient temperature should be maintained in the range 0-40 deg C and humidity between 20 to 90%.

Over the life of the controller, a build-up of dust or dirt can result in the controller operating at a higher temperature than normal.

The controller should be installed where airborne dust is minimised.

The cover should be removed periodically and vacuum or low pressure air used to remove any build-up of dust or dirt especially on the PCB's, on the fan and on the cooling plate/heatsink fins.

While the cover is removed, check the control terminal screws are tight.

The iSub cabinet is fitted with a cooling fan to assist with controlling temperature. If the operation of the fan is compromised or the fan has failed, abnormal operation will result.

- Fans and capacitors are considered wearing parts.
- Expected fan life = 20,000 hours running. (Check accumulated run time hours at **b06.08**)
- Expected capacitor life = 30 – 40,000 hrs running,
- Abnormal appearance, colour or smell indicates that the capacitor should be replaced
- 

Cooling fan should be replaced every 2 years.

Replace the capacitors every 5 years.

## 22. Warranties – Terms and Conditions

This warranty is given in addition to the consumer guarantees found within the Australian Competition and Consumer Act 2010 (Cth) for goods purchased in Australia and the Consumer Guarantees Act 1993 NZ for goods purchased in New Zealand:



- 1) White International Pty Ltd / White International NZ Ltd (White International) warrant that all products distributed are free from defects in workmanship and materials, for their provided warranty period as indicated on the top or opposite side of this document. Subject to the conditions of the warranty, White International will repair any defective products free of charge at the premises of our authorised service agents throughout Australia and New Zealand if a defect in the product appears during the warranty period. If you believe that you have purchased a defective product and wish to make a claim under this warranty, contact us on our Sales Hotline on 1300 783 601, or send your claim to our postal address or fax line below and we will advise you as to how next to proceed. You will be required to supply a copy of your proof of purchase to make a claim under this warranty.
- 2) This warranty excludes transportation costs to and from White International or its appointed service agents and excludes defects due to non-compliance with installation instructions, neglect or misuse, inadequate protection against the elements, low voltage or use or operation for purposes other than those for which they were designed. For further information regarding the suitability of your intended application contact us on our Sales Hotline on 1300 783 601. If you make an invalid claim under this warranty, the original product will be sent back to you unrepaid.
- 3) This warranty refers only to products sold after the 1st January 2012, and is not transferable to another product type and only applies to the original owner, purchaser or end user, and is in addition to the consumer guarantees found within the Competition and Consumer Act 2010 (Cth) for goods purchased in Australia and the Consumer Guarantees Act 1993 (NZ) for goods purchased in New Zealand.
- 4) Our goods come with guarantees that cannot be excluded under the Australian Consumer Law. You are entitled to a replacement or refund for a major failure and for compensation for any other reasonably foreseeable loss or damage. You are also entitled to have the goods repaired or replaced if the goods fail to be of acceptable quality and the failure does not amount to a major failure. **2 YEAR WARRANTY**
- 5) To the fullest extent permitted by law, White International excludes its liability for all other conditions or warranties which would or might otherwise be implied at law. To the fullest extent permitted by law, White International's liability under this warranty and any other conditions, guarantees or warranties at law that cannot be excluded, including those in the Competition and Consumer Act 2010 (Cth), is expressly limited to: (a) in the case of products, the replacement of the product or the supply of equivalent product, the payment of the cost of replacing the product or of acquiring an equivalent product or the repair of the product or payment of the cost of having the product repaired, is at the discretion of White International or a 3rd party tribunal elected under the Competition and Consumer Act 2010 (Cth) for goods purchased in Australia and the Consumer Guarantees Act 1993 (NZ) for goods purchased in New Zealand; and
- 6) To the fullest extent permitted by law, this warranty supersedes all other warranties attached to the product or its packaging.
- 7) In the case of services, supplying the services again or the payment of the cost of having the services supplied again, is at the discretion of White International or a 3rd party tribunal elected under the Competition and Consumer Act 2010 (Cth) for goods purchased in Australia and the Consumer Guarantees Act 1993 (NZ) for goods purchased in New Zealand. 8) Our warranty commences from the date of purchase of the above mentioned pumps. Proof of purchase is required before consideration under warranty is given.

*Record your date of purchase in the space below and retain this copy for your records.*

**Date of Purchase** ..... **Model Purchased** .....



**[www.whiteint.com.au](http://www.whiteint.com.au)**  
**[www.whiteint.co.nz](http://www.whiteint.co.nz)**

**Please always refer to our website for further technical information & new product innovations**

**Disclaimer:** Every effort has been made to publish the correct information in this manual. No responsibility will be taken for errors, omissions or changes in product specifications.

© 2020 Copyright White International Pty Ltd

**TM ® - WARNING:** Please be aware that various brands & products depicted within this document are subject to trademark, patent or design registrations. Infringement of any intellectual property contained within this document without express written authority by the appropriate intellectual property holder may result in further legal action to be taken. For any queries regarding use of the contained information please feel free to contact White International Pty Ltd.